

# QuikVang Manual

Hall Spars & Rigging designed the QuikVang and its accessory items to simplify sailing and improve boat performance. To increase the benefits of the QuikVang on your boat, please read the following instructions carefully. Contact your dealer or Hall Spars & Rigging if, after reading these instructions, you have any questions about proper installation.

## Installation and Maintenance for an A-VANG

### QuikVang Installation

To ensure proper function, the QuikVang requires specific mast and boom fittings. Listed below are the reasons for this requirement.

**Boom fitting required** - fixed lug. A conventional bail works only in tension; it will not allow the QuikVang to support the boom weight.

**Mast fitting required** - swiveling gooseneck. This will maintain constant tension at each boom swing angle, and will support the boom.

### Installation Instructions if Mast and Boom Do Not Have Proper Fittings

If you have the proper fittings, skip this section.

1. Order QuikVang mast and boom fittings through your dealer, properly matching the fittings to the size of your QuikVang. QuikVang mast and boom fittings fit a variety of mast and boom sections. However, check the suitability for your particular mast before installation. If fittings do not appear to fit, contact Hall Spars & Rigging for advice.

2. Adjust set spring tension adjustment to middle of range.

- A. Remove set screws.
  - B. Push knob to desired location.
  - C. Line up to nearest tapped hole.
  - D. Reinsert set screws (tapped holes are at one-inch intervals).
- Once mast and boom fittings are installed and spring position is confirmed, remove vang, ease tackle, and reinstall set screws with Blue Loctite.

**Caution** — Never adjust spring tension setting with the vang attached to the boom.

**Figure 5** — Locating mast and boom fittings (See 3. below)

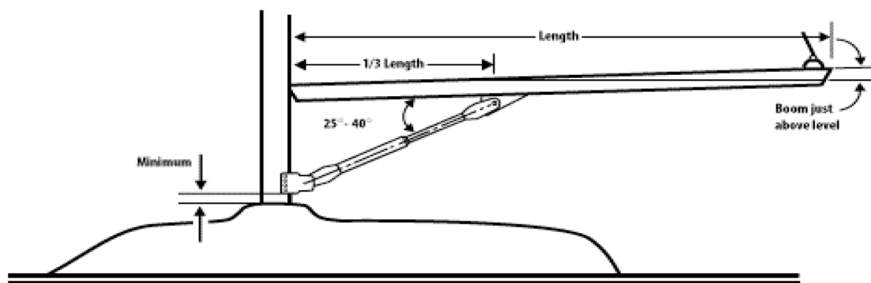

### Diagrams

**Figure 1** — Two-tiered tensioning system achieves maximum mechanical advantage.

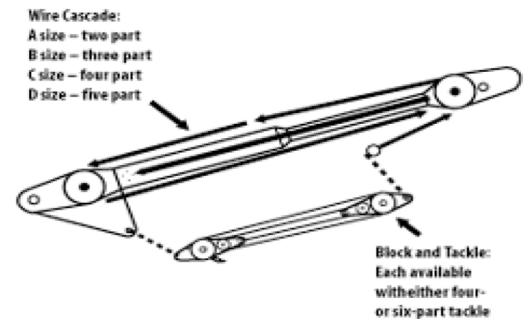

**Figure 2** — Telescopic action of tube is smooth by virtue of Delrin® slider parts

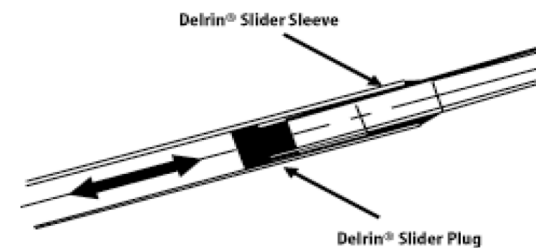

**Figure 3** — Strong return spring holds up boom and furled sail.

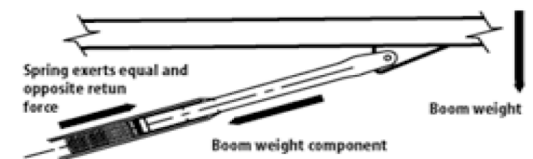

3. Locate mast and boom fitting positions.

- A. Attach mast and boom fittings to QuikVang.
- B. Attach main halyard to end of boom and lift it to a position slightly above level.
- C. Locate mast fitting as low as possible while still allowing clearance with other mast fittings, collar, boot, etc.

**NOTE** — Do not attach mast fitting at this time.

- D. Reinsert set screws (tapped holes are at one-inch intervals).
- E. Lift vang until boom fitting contacts the boom while holding the mast fitting in place.
- F. Check the orientation of the vang for best use by positioning vang about 1/3 of boom length from gooseneck and positioning vang angle with boom about 25 to 40 degrees.
- G. Check boom swing for potential contact with hatches, dorades, etc.

H. Reset spring adjustment and repeat sequence, if the QuikVang position does not meet criteria in item f above.

4. Attach mast and boom fittings, following instructions below.

**NOTE** — Hall Spars & Rigging designed and tested mast and boom fitting for tapped screw installation. Inherent in our design assumptions are proper drilling and tapping of holes. We strongly advise hiring a professional rigger if you are unsure of proper drilling and tapping procedures for vang fitting installation.

**Mast Fitting**

- 1. Mark and check positions of mast and boom fittings.
- 2. Hold mast fitting at position marked.
- 3. Center mast fitting side to side.
- 4. Mark upper-most port and starboard holes.
- 5. Drill and tap two upper-most holes (fastener size 10-24 x 5/8" flat head machine screw).
- 6. Fasten mast fitting to mast with two top fasteners.

**NOTE** — Do not tighten fasteners at this stage of installation.

- 7. Center the bottom of the mast fitting.
- 8. Mark carefully for bottom-most holes.
- 9. Drill and tap bottom holes with fitting in place.
- 10. Install fasteners as in step f, above.
- 11. Drill and tap remaining holes.
- 12. Install fasteners while checking fit.
- 13. Remove all fasteners and clean out chips behind mast fittings.
- 14. Install mast fitting while applying Blue Loctite to each fastener.
- 15. Tighten all fasteners.

**Boom Fitting**

- 1. Check chosen position.
- 2. Drill and tap fore and aft end holes (fastener size 1/4 x 20 x 1" socket head cap screw).
- 3. Install end fasteners.
- 4. Drill and tap remaining holes.
- 5. Check for proper fit.
- 6. Remove all screws and clean out chips from behind fitting.
- 7. Install fitting while applying Blue Loctite to all fasteners.
- 8. Tighten all fasteners.

**Figure 4** — Setting spring tension adjustment

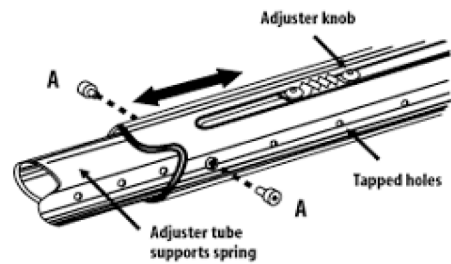

**Figure 6** — Rule of thumb: B should at least equal A.

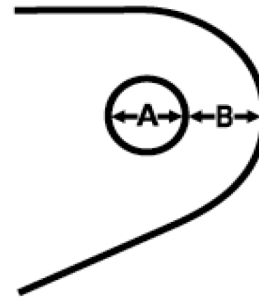

## Installation Instructions if Mast and Boom Appear to Have Proper Fittings

1. Check Fittings to determine that vang fits.
  - A. Hole size: If too small, open up, making sure that "meat" around hole is enough (see diagram).
  - B. Lug thickness: If much smaller than QuikVang jaw opening, contact Hall Spars & Rigging.
2. Lift boom up to just above level.
3. Measure pin-to-pin length between boom fitting and mast fitting.
4. Remove spring adjuster set screws from vang (see vang adjustment procedure).
5. Set vang at pin to pin length dimension as determined in step 3, above.
6. Install spring adjuster set screws in nearest tapped holes.
7. Temporarily install QuikVang to check length.
8. Remove QuikVang from boom fitting.
9. Remove set screws and install with Blue Loctite.

**Caution** — Do not remove spring adjuster set screws with QuikVang installed.
10. Install QuikVang.

## Using Your QuikVang

- Beware of oversheeting the main. If the QuikVang bottoms out while trimming the mainsheet, compression can bend the boom in reverse. This situation can also cause the vang to fail in compression bending.
- Never lean on the end of the boom with a furled sail. Your weight creates a great load on the vang if it bottoms out. The same compression failure could occur as discussed in the previous caution note.
- It's always good practice to attach the main halyard to the end of the boom after furling the sail. This procedure allows the tightening of the mainsheet and removes the risk of damage to the QuikVang.
- Put a knot in the tackle line at the maximum open position. This is the position just before the wire dead end of the purchase reaches its turning sheave. This way, the wire will not jam in the turning sheave when releasing the vang.

## Maintenance

As with any marine fitting, especially when exposed to salt water, the QuikVang requires regular maintenance and inspection. On a semi-annual basis, the following maintenance should be performed.

**Caution** — All maintenance should be done on the vang only after it is removed from the bottom and the tackle is totally relaxed.

- Remove all screws and lubricate with FEL PRO C5-A or similar anti-seize lubricant. Left alone, stainless screws will freeze themselves in aluminum parts.
- Regularly check all screws (especially spring tension set screws) to ensure they are not backing out.
- Lubricate surface of spring with Lubriplate or similar grease to eliminate creaking of spring. Very little lubricant is required—do not over do.
- Regularly check to make sure all sheaves rotate freely and lubricate with WD 40.
- Regularly check wire cascade for wear. If frayed, replace at once.

## A-Vang Parts List Diagram

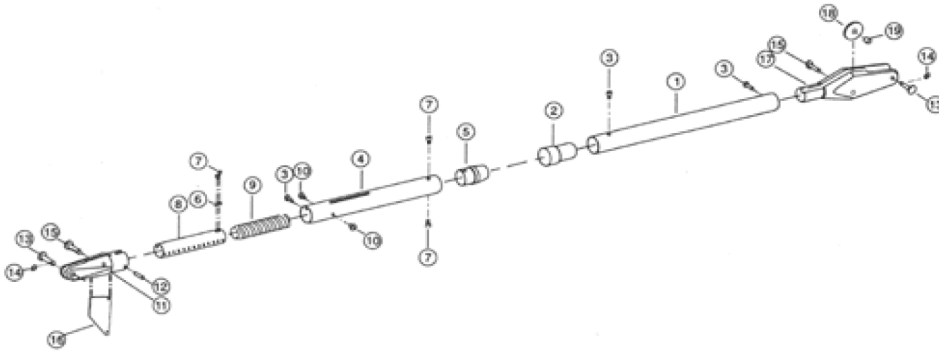

## A-Vang Parts List

Item	Part Number	Description
1	PR-8677	Upper Tube
2	PR-8678	Slider Plug / Plug
3 & 10	HSM-10NFX1/4	Hex Socket Machine 10-32 x 1/4" (5)
4	PT-8676	Lower Tube
5	PR-8679	Slider Sleeve / Sleeve
6	PR-8672	Slider Knob
7	HRM-10NFX1/4	Hex Round Machine 10-32 x 3/8" (4)
8	PR-8682	Spring Adjuster / Adjuster Tube
9	PR-8685	Charged Spring
11	PR-8675	Inboard End
12	MSC-76023126	Dead End Pin
13	NAV-600-6-117	Clevis Pin
14	SHC-94-93-PK	Cotter Ring 5/16" (2)
15	HMS-5/16X1	Hex Socket Machine 5/16-18 x 1" (2)
16	PR8680	Anchor Plate
17	PR8674	Outboard End
18	PR8681	Sheave 1-3/8"
19	PR-11185	Spacer
20	HR-A-WIRE	Quik Vang Wire

### QuikVang A-8: 4:1 Purchase HRQV-A8

HAR-053NP	Harken Block
HAR-060	Harken Block
HAR-A8-ROPE	Custom Yale Dacron® Braid 5/16" Whole Unit

### QuikVang A-12: 6:1 Purchase HR-QV-A12

HAR-190SNP	Harken Block
HAR-129NP	Harken Block
HAR-A12-ROPE	Custom Yale Dacron® Braid 5/16" Whole Unit